

MODEL #109SRE CONCRETE PICNIC TABLE WITH
RIGHT SIDE WHEELCHAIR ACCESS

OUTDOOR CREATIONS, INC.

SCALE: 1" = 32"

MAN. TOL. +/- 1/4"

CUSTOMER APPROVAL x _____

DRAWN BY: MNC

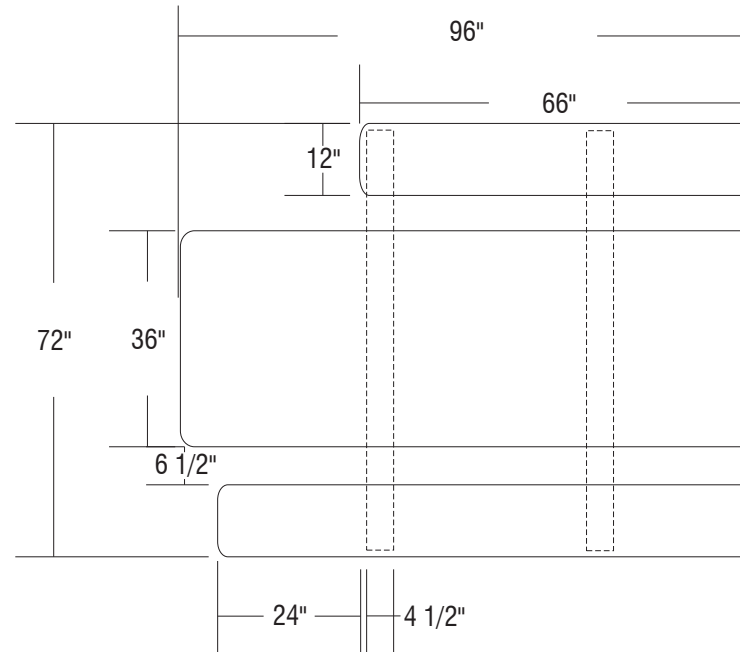
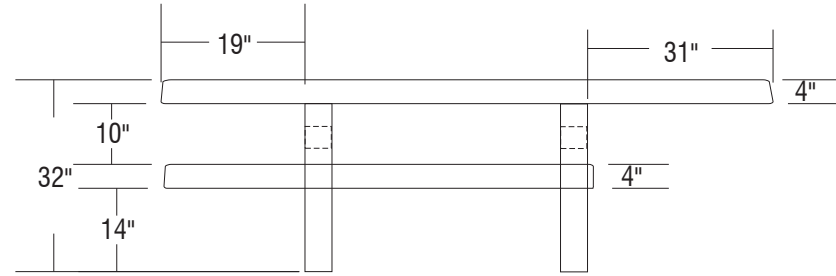
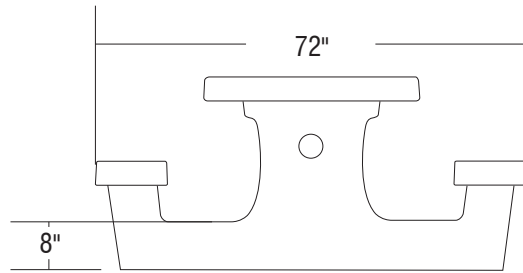

NOTES:

1. Concrete mix design to include a mixture of Portland Cement, water, coarse and fine aggregates, pure mineral oxide coloring agents (when applicable) to yield a minimum compressive strength of 5000 psi.
2. Final product shall be reinforced with #4 and #5 rebar grid.
3. Product is cast in 1-piece with no assembly required.
4. Hairline cracks may develop over time. These are not structural failures, but inherent characteristics of the material itself.
5. Air pockets are a common occurrence in precast products. The frequency and size of air pockets are variable and to be expected, especially on vertical surfaces.
6. Concrete corners and edges will chip if not handled according to guidelines. Patch kits are available but may or may not blend and can be variable.
7. There is a level of care and maintenance associated with your product and is the responsibility of the end user. Choosing the right sealer can help minimize those costs.

WEIGHT: 2350 LBS
TEXTURE:
COLOR:
SEALER:

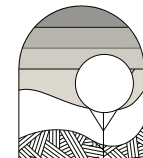

**OUTDOOR
CREATIONS
INC.**
2270 Barney Street
Anderson, CA 96007
(530) 365-6106
FAX (530) 365-5129